

A77

6MP Outdoor Dome with D/N, IR, Extreme WDR, SLLS, Fixed Lens



- 6 Megapixel
- Day & Night with Superior Low Light Sensitivity and IR LED
- Fixed Lens with f2.8mm/F1.6
- Extreme WDR
- Super wide angle
- Taiwan IoT Cybersecurity Certification Level 1 (TAICS)
- Event trigger, response and notification

► Specifications

Device

Product Type	Dome
Maximum Resolution	6MP
Application Environment	Outdoor
Image Sensor	Progressive Scan CMOS
Sensor Size	1/2.7 "
Effective Pixels	3864(H) X 2192(V) (8.46 MP)
Day / Night	Yes
Low Light Sensitivity	Superior
Minimum Illumination	Color: 0.003 lux; B/W: 0 lux (IR LED on)
Mechanical IR Cut Filter	Yes
IR LED	IR LED x 3 (850 nm)
IR Working Distance	65m
Electronic Shutter	1/5-1/100000 second (auto mode)
S/N Ratio	75 dB

Lens

Focal Length	Fixed focal, f2.8mm
Aperture	F1.6
Iris	Fixed iris
Focus	Fixed focus
Lens Mount	Board mount
Horizontal Viewing Angle	103.6°
Vertical Viewing Angle	56°
Viewing Angle Adjustment	Pan: 0°-355°, Tilt: 0°-75°, Rotation: 0°-355°

Video

Compression	H.265, H.264 (Main/ High profile), MJPEG
Maximum Frame Rate vs. Resolution	20 fps at 3200 x 1800 20 fps at 3072 x 2048 20 fps at 2592 x 1944 30 fps at 2688 x 1520 30 fps at 2560 x 1440 30 fps at 1920 x 1080 30 fps at 1280 x 960 30 fps at 1280 x 720 30 fps at 640 x 480
Multi-Streaming	Simultaneous quad streams
Bit Rate Mode	Constant, Variable
Wide Dynamic Range	Extreme WDR (150 dB)
Image Enhancement	White Balance, Brightness, Contrast, Sharpness, Saturation, Backlight compensation (BLC), Strong Light Suppression
Digital Noise Reduction	2D + 3D DNR
Privacy Mask	4 configurable regions
Text Overlay	Yes
On-Screen Graphics (Picture Overlay)	Yes
Built-in Analytics	Deep Learning : Face Detection, Tampering Detection, Object Based Motion Detection, Object Line Crossing Detection, Object Enter Area Detection, People Line Crossing Detection, People Enter Area Detection, Vehicle Line Crossing Detection, Vehicle Enter Area Detection
Image Orientation	Flip, Mirror, Rotation (Corridor mode) (90°, 180°, 270°)

Audio

Audio Type	2-way, Line-in, Line-out
Audio Compression	PCM, G.711, AAC(*3), G.726(*3)

Network

Network Protocol & Service	IPv4, IPv6(*3), TCP, UDP, DHCP, PPPoE, HTTP, HTTPS, DNS, DDNS, NTP, RTP, RTSP, RTCP, SMTP, FTP, SFTP, IGMP, ICMP, UPnP, QoS, SNMP, IEEE 802.1X
Ethernet Port	1 x Ethernet (10/100 Base-T), RJ-45 pigtail connector
Security	IP address filtering, HTTPS encryption, Password protected user level, Anonymous login, IEEE 802.1X network access control, Standard IoT Security (anti-hacking, anti-malware)

Event

Event Trigger	Video motion detection (4 polygonal regions with up to 10 vertices), External device through digital input, Intelligent event detection, Sound detection, Video streams loss, System log buffer overrun, Remove system log, Logon events (Login Failure, Login Success, Block an Account)
Event Response	Notify control center, Change camera settings, Command other devices, E-mail notification with snapshots, Play the audio file, Push notification to mobile device, Save video to local storage, Upload video to NVR server, Upload video or snapshot to FTP server, Activate external device through digital output

System

System Monitor	CPU loading, memory usage and network statistics via API
System Log	Support
Watchdog	Support

Integration

Unified Solution	Fully compatible with ACTi software
GPS Position	Manual setting
Edge Recording	Support (integration with NVR by ONVIF Profile G or proprietary protocol)(*2)
ONVIF Compliant	Yes, Profile S, Profile G, Profile T, Profile M
Web Browser	IE 11, Google Chrome*, Microsoft Edge*, Apple Safari*
Auto Firmware Upgrade	Yes

Interface

Local Storage	MicroSD, MicroSDHC, MicroSDXC Memory Card Slot (card not included, up to 256GB, Kingston or Sandisk only)
Digital Input/Output	1/1 (Terminal block)
Operating Button	Reset Button

General

Power Source	DC 12V, PoE Class 3 (IEEE802.3af)
Power Consumption	7.5 W (PoE)
Dimensions	(Ø x H): 110.82mm x 84.7mm (4.36" x 3.33")
Environmental Casing	Weatherproof (IP68), Vandal proof (IK10)
Mount Type	Wall Mount, Pole Mount, Pendant, Flush, Gang Box
Operating Temperature	-40°C ~ 60°C (-40°F ~ 140°F)
Approvals	CE Class B, FCC Class B, IP68, IK10, UL Listed, Taiwan IoT Cybersecurity Certification Level 1 (TAICS)
Color	White
Real-time Clock (RTC)	Yes
Warranty	3 Year(s). For extended warranty offering, see http://www.acti.com/support/warranty

* cross-browser compatibility: Not available for H.265 video decoding *3 To be available through future firmware upgrade

► Photo Indication

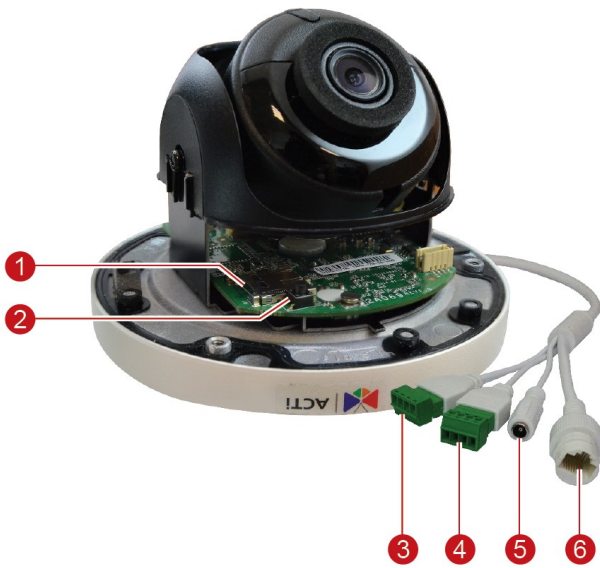

- 1 Memory Card Slot
- 2 Reset Button
- 3 Audio Input / Output
- 4 Digital Input / Output
- 5 DC 12V Power Input
- 6 Ethernet Port

► Dimension Diagram

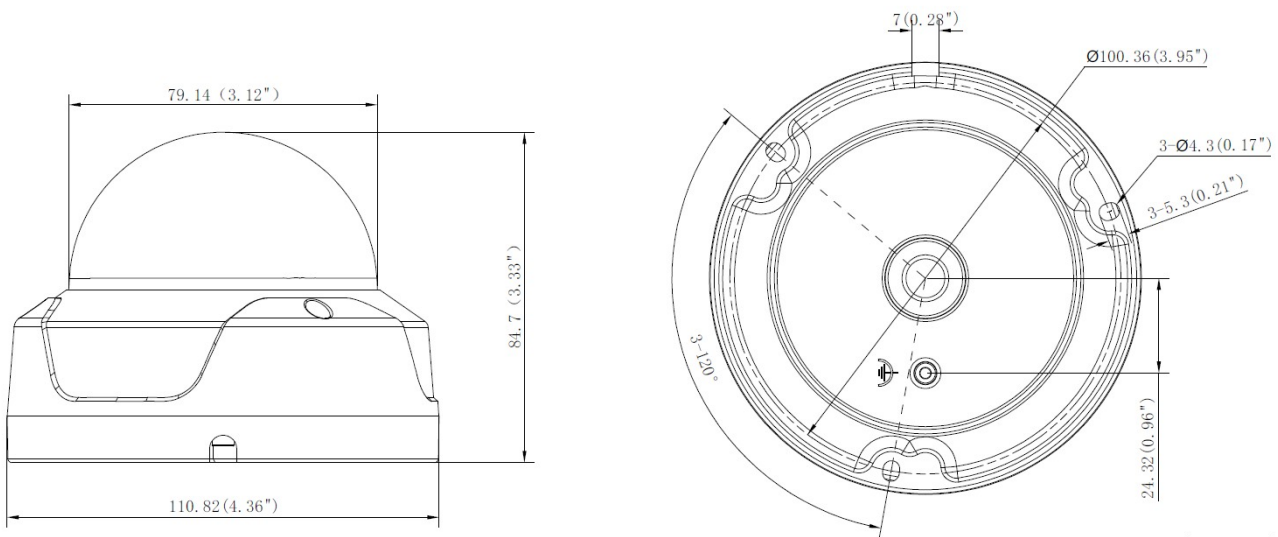













Unit: mm (inch)

Unit: mm [inch]

► Related Products

Mounting Accessories - Camera Mount

PMAX-0122		Straight Tube (for A71, A88, A9x,)
PMAX-0123		Extension Tube (for A71, A88, A9x,)
PMAX-0128		Pendant Mount (for Z85, Z86, Z87, Z810)
PMAX-0318		Wall Mount (for Z91, Z97, Z98, Z710, Z714, Z715, A71, A76, A77)
PMAX-0323		Wall Mount with Built-in Junction Box (for Z91, Z94, Z95, Z97, Z98, Z77, Z81, Z82, Z85, Z86, Z87, A7X)
PMAX-0506		Pole Mount (for A31, A4x, E78, E9x, E9xx), supports 2" to 3" Poles
PMAX-0527		Pole Mount (for Z4x, Z710, Z8x, Z9x, A7x), supports 2.64" to 5" Poles
PMAX-0532		Pole Mount (Z710, Z8x, Z9x, A7x), supports 2.6" to 5" Poles
PMAX-0718		Junction Box (for A71, A74, A77)
PMAX-0816		Converter Ring, 1.0" NPT for Third-Party Mounting Accessories, White
PMAX-0820		Gang Box Converter (for A71, A74, Z91, Z94, Z95), supports 4" Round and 4" Octagon Boxes
PMAX-1032		Flush Mount (for A71, A74, A77, E78, E79, E710)
PMAX-1402		Mount Kit (for Z91, Z97, Z98, Z710, Z714, Z715, A71, A76, A77)

Note: Some mounting accessories may need additional accessories for installation. Please check www.acti.com/mountingselector for more information.

Power Supply Accessories - Power Adapter

PPBX-0013		Power Adapter AC 100~240V (EU), for A3x, A4x, A88, A9x, Z31, Z8x, Z9x
PPBX-0014		Power Adapter AC 100~240V (UK), for A3x, A4x, A88, A9x, Z31, Z8x, Z9x
PPBX-0026		Power Adapter AC 100~240V (US) for A3x, A4x, A7x, A88, A9x, Z3x, Z4x, Z7x, Z8x, Z9x

Audio Devices - Microphone

PMIC-0100



Active Microphone Omnidirectional for all Cameras with Line-in Audio