

A811

4MP Outdoor Zoom Dome with D/N, IR, Extreme WDR, SLLS, 5x Zoom Lens



- 4 Megapixel
- Day & Night with Superior Low Light Sensitivity and IR LED
- Extreme WDR
- H.265 Compression
- Super wide angle
- Event trigger, response and notification

► Specifications

Device

Product Type	Zoom Dome
Maximum Resolution	4MP
Application Environment	Outdoor
Image Sensor	Progressive Scan CMOS
Sensor Size	1/2.7 "
Day / Night	Yes
Low Light Sensitivity	Superior
Minimum Illumination	Color: 0.01 lux; B/W: 0 lux (IR LED on)
Color to B/W Switch	ISP based switch, configurable
Mechanical IR Cut Filter	Yes
IR LED	IR LED (850 nm)
IR Working Distance	85m (1.0 lux)
Electronic Shutter	1/5-1/64000 second (manual mode); 1/5-1/64000 second (auto mode)

Lens

Focal Length	Zoom, f2.7-13.5mm
Aperture	F1.6

Zoom Ratio	5x optical
Focus	Auto focus
Lens Mount	Board mount
Horizontal Viewing Angle	110° - 31°
Vertical Viewing Angle	58° - 18°
Viewing Angle Adjustment	Pan: 0°-355°, Tilt: 0°-75°, Rotation: 0°-355°

Video

Compression	H.265, H.264 (Main/ High profile), MJPEG
Maximum Frame Rate vs. Resolution	25 fps at 2688 x 1520 30 fps at 2560 x 1440 30 fps at 1920 x 1080 30 fps at 1280 x 960 30 fps at 1280 x 720 30 fps at 640 x 480
Multi-Streaming	Simultaneous quad streams
Bit Rate	128Kbps - 12Mbps (per stream)
Bit Rate Mode	Constant, Variable
Wide Dynamic Range	Extreme WDR (150 dB)
Image Enhancement	White Balance, Backlight compensation, Brightness, Contrast, Sharpness, Automatic gain control, Defogging
Digital Noise Reduction	3D DNR
Privacy Mask	Yes
Text Overlay	Yes
Built-in Analytics	Tampering Detection*, Face Detection*, Object Line Crossing Detection*, Object Enter Area Detection*
Server-based Analytics	Object Line Counting, People Counting, Face Detection, Object Based Motion Detection, Tamper, Object Line Crossing Detection, Object Enter Area Detection, Missing Object Detection, Unattended Object Detection, Smoke Detection, Heat Map, Dwell Time, Direction Detection, Automatic License Plate Recognition, People Queue Detection, (Require PC-based or standalone IVS or ALPR Server. Contact ACTi support for recommendations on how to maximize analytical accuracy)
Image Orientation	Flip, Mirror, Rotation

Audio

Audio Type	2-way, Mic-in, Line-in, Line-out
Audio Compression	G.711

Network

Network Protocol & Service	IPv4/v6, TCP, UDP, DHCP, PPPoE, HTTP, HTTPS, DNS, DDNS, NTP, RTP, RTSP, RTCP, SMTP, FTP, IGMP, ICMP, Bonjour, UPnP, QoS, SNMP, IEEE 802.1X
Ethernet Port	1 x Ethernet (10/100 Base-T), RJ-45 connector
Security	IP address filtering, HTTPS encryption, Password protected user level, Anonymous login, IEEE 802.1X network access control

Event

Event Trigger	Video motion detection (10 included and excluded regions), External device through digital input, Sound detection, Tampering detection
---------------	--

Integration

GPS Position	Manual setting
ONVIF Compliant	Yes, Profile S, Profile G, Profile Q, Profile T

Web Browser	IE 11
Auto Firmware Upgrade	Yes

Interface

Audio Interface	Terminal block
Local Storage	MicroSD, MicroSDHC, MicroSDXC Memory Card Slot (card not included, up to 128GB)
Digital Input/Output	1/1 (Terminal block)

General

Power Source	DC 12V, PoE Class 3 (IEEE802.3af)
Power Consumption	10 W (DC), 12 W (PoE)
Weight	835g (1.8lb)
Dimensions	(Ø x H): 153.3mm x 111.6mm (6.0" x 4.4")
Environmental Casing	Weatherproof (IP67), Vandal proof (IK10)
Operating Temperature	-30°C ~ 60°C (-22°F ~ 140°F)
Approvals	CE, FCC, IP67, IK10
Warranty	3 Year(s)

* To be available through future firmware upgrade

► Photo Indication



- 1 DC 12V Input
- 2 Ethernet Port
- 3 Reset Button
- 4 Memory Card Slot



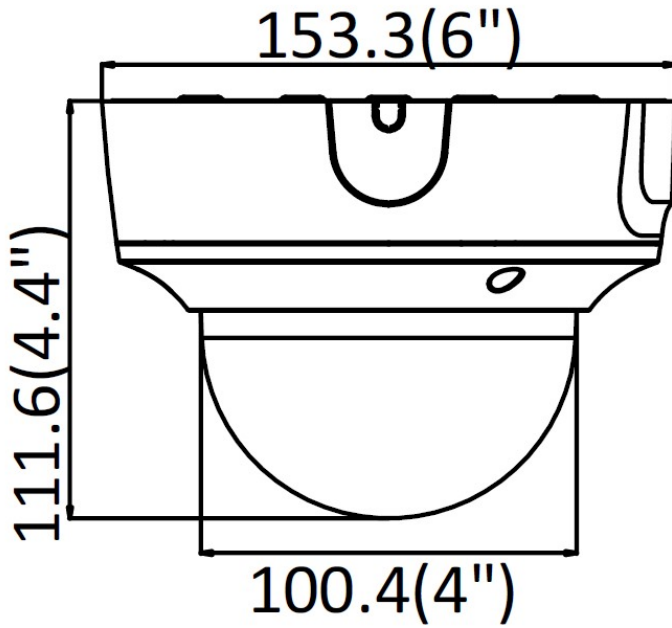













► Dimension Diagram



Unit: mm [inch]

► Related Products

Mounting Accessories - Camera Mount

PMAX-0102		Straight Tube
PMAX-0103		Straight Tube with Bracket
PMAX-0104		Extension Tube
PMAX-0114		Mount Kit for Dome Cameras (for A8x, except A88)
PMAX-0302		Gooseneck with Bracket
PMAX-0303		Gooseneck
PMAX-0321		Heavy Duty Wall Mount for Outdoor Domes (for A8x, except A88)
PMAX-0402		Corner Mount
PMAX-0503		Pole Mount (for PMAx-0102, PMAx-0312, PMAx-0313, PMAx-0314, PMAx-0702, PMAx-1106, PMAx-1107), supports 5.25" to 8.5" Poles
PMAX-0505		Pole Mount (for B4x, B41x, E44, E45, E46, E48, E44A, E45A, E46A, E41x, I4x, PMAx-0312, PMAx-0313, PMAx-0314, PMAx-0330), supports 2" to 3" Poles
PMAX-0702		Junction Box for PTZ and Dome Cameras
PMAX-0717		Junction Box for PTZ and Dome Cameras
PMAX-0722		Junction Box (for A811, A813, A818)
PMAX-0807		Gangbox Converter (for PMAx-0102, PMAx-0312, PMAx-0313, PMAx-0314, PMAx-0321), supports Two-Gang Boxes
PMAX-0808		Converter Ring, 1.5" NPT for Third-Party Mounting Accessories
PMAX-0817		Converter Ring, 1.5" NPT for Third-Party Mounting Accessories White
PMAX-1030		Flush Mount (for A811, A813, A818)

Note: Some mounting accessories may need additional accessories for installation. Please check www.acti.com/mountingselector for more information.